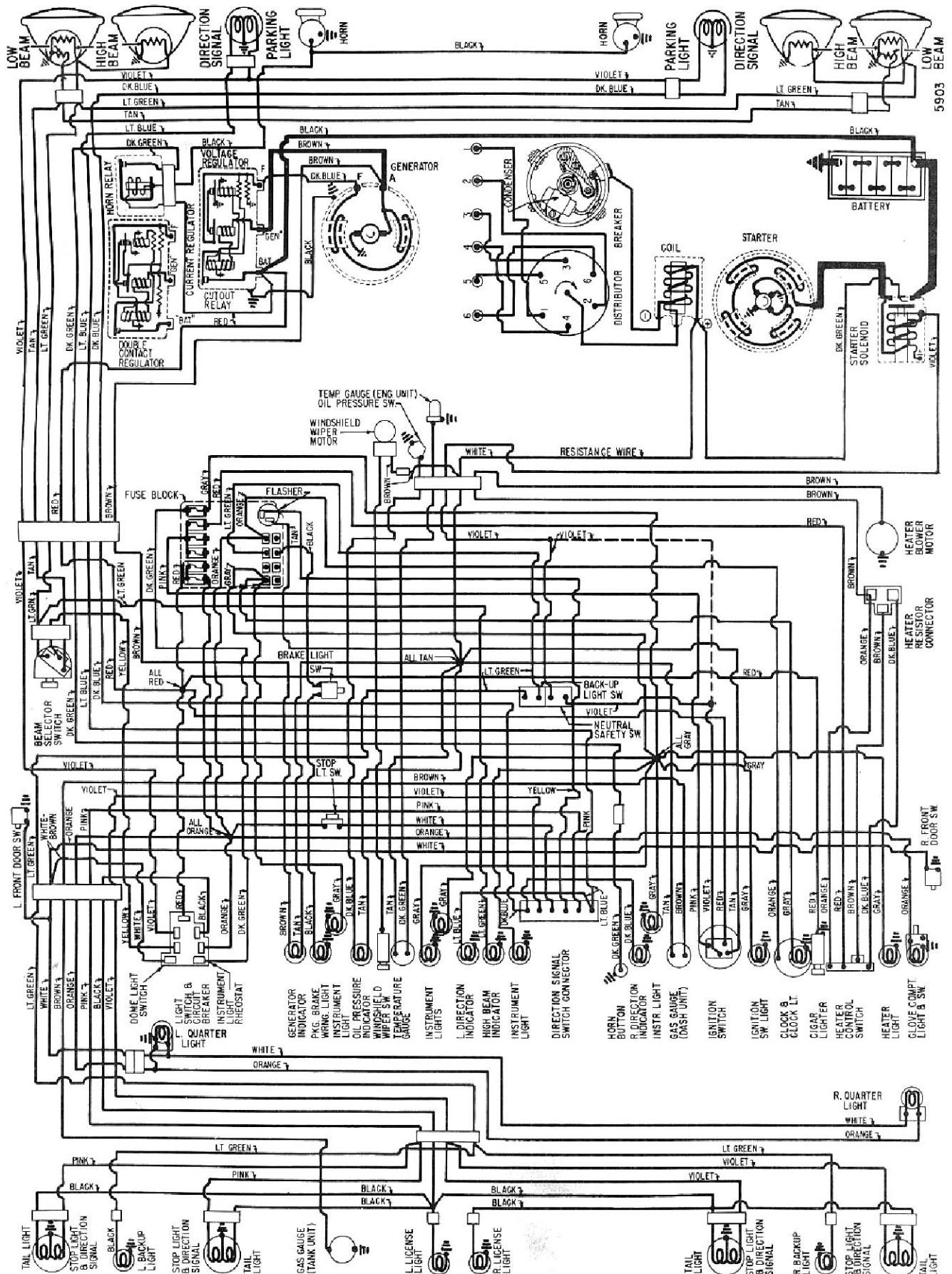


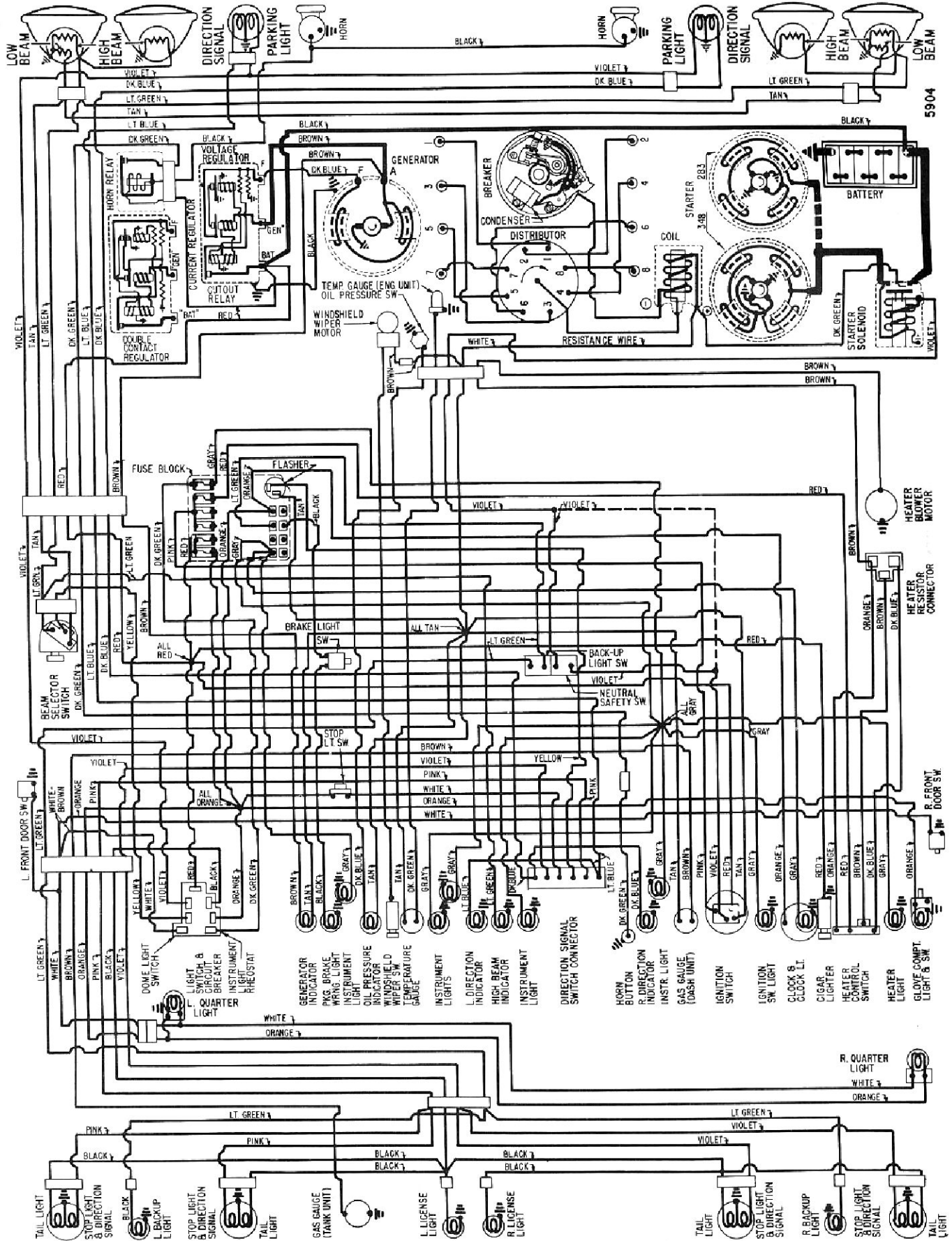
1959 Chevrolet 6

Biscayne
Belair
Impala



1959 Chevrolet V8

Biscayne
Belair
Impala



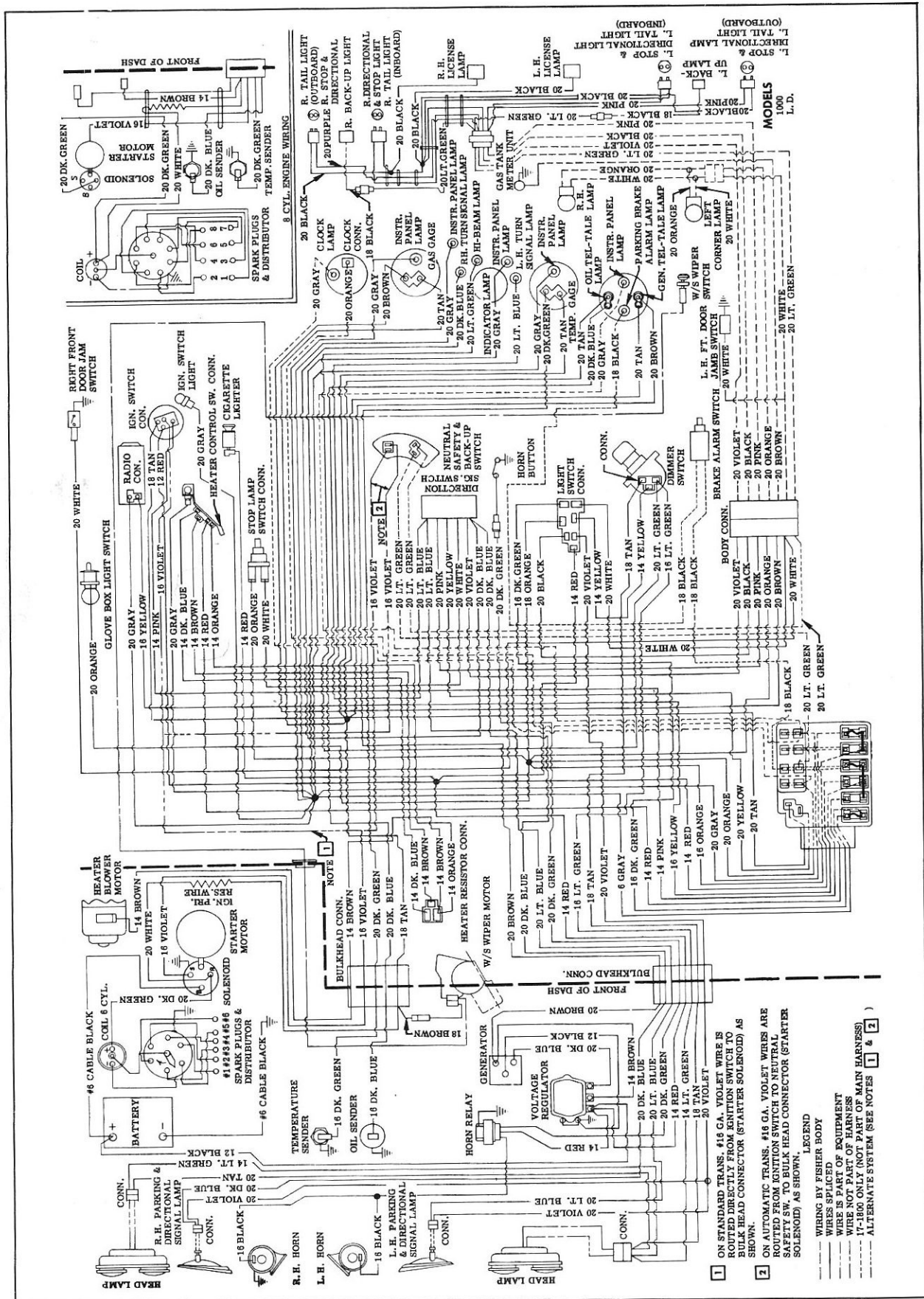


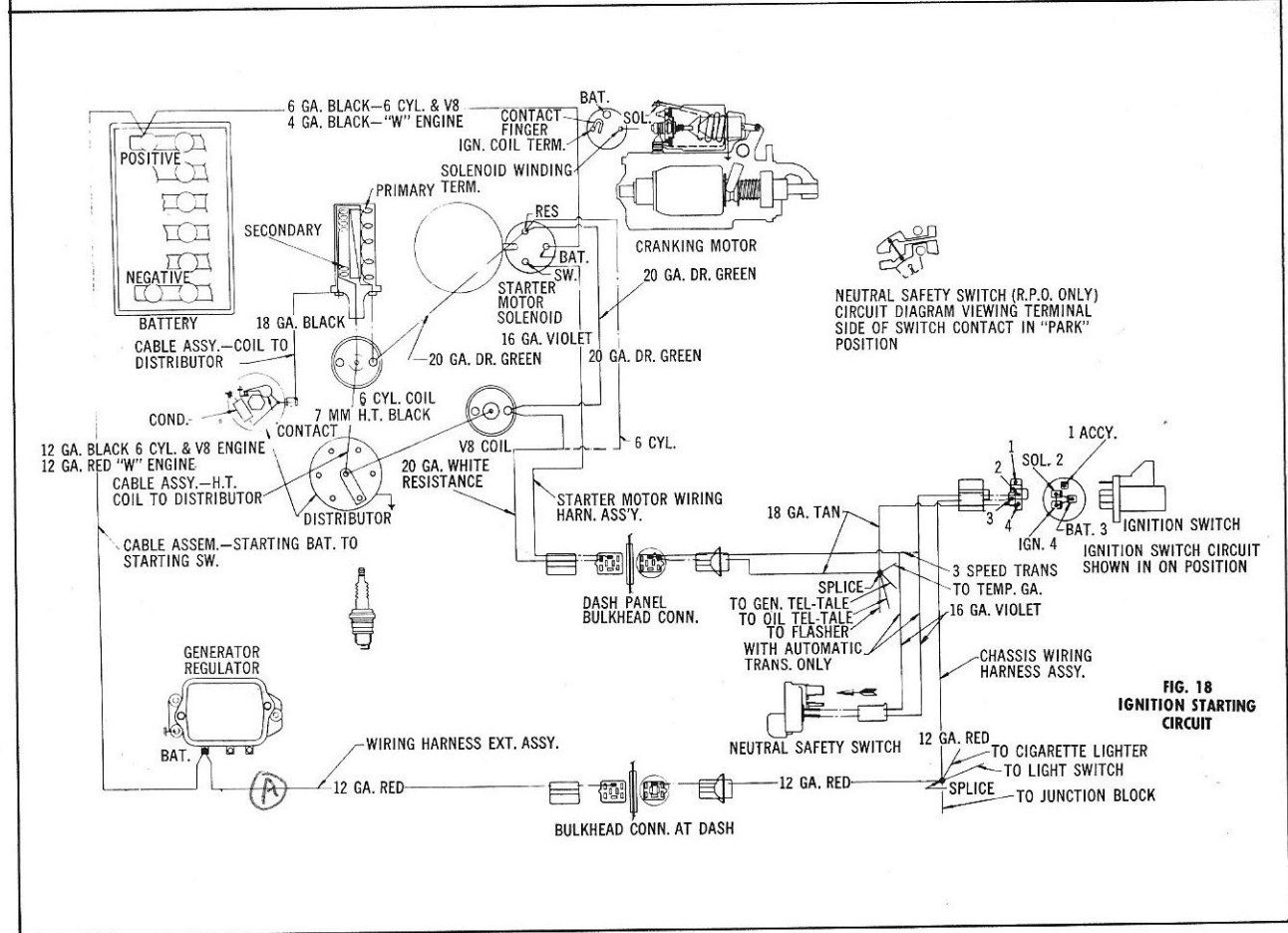
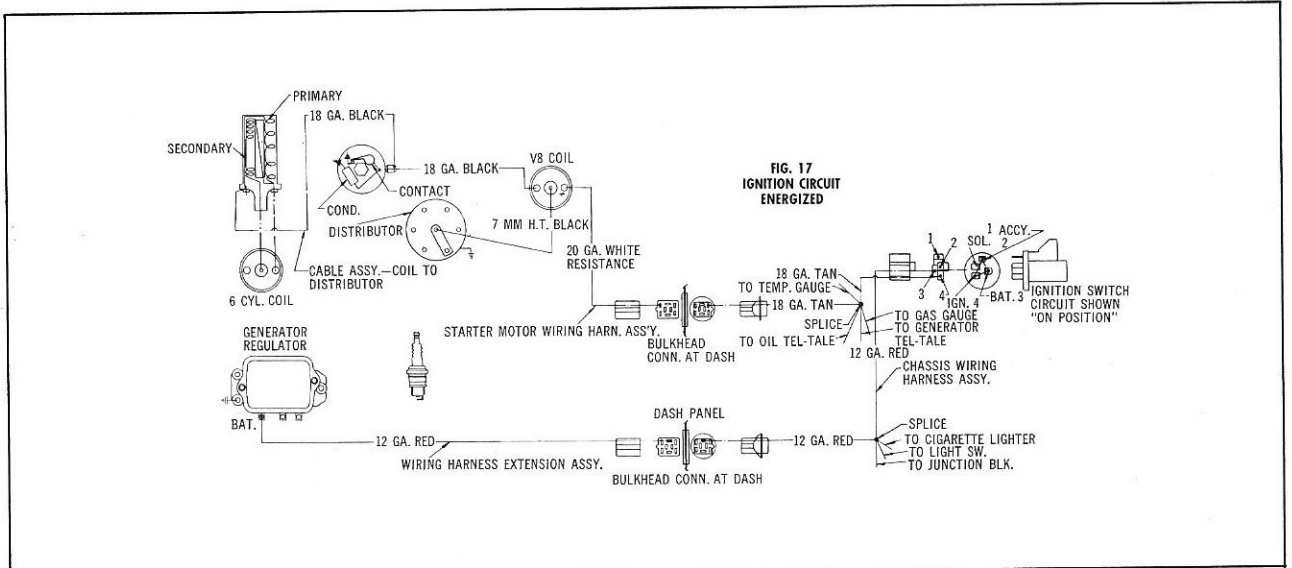
Fig. 16—Wiring Diagram—1959 Only

CHASSIS ELECTRICAL

WIRING

The wiring diagram shown as Figure 16 shows the various electrical units and circuits in the 1959 Passenger Car. The wiring diagrams (Fig-

ures 17-58) show all circuits for the 1960 Passenger car.



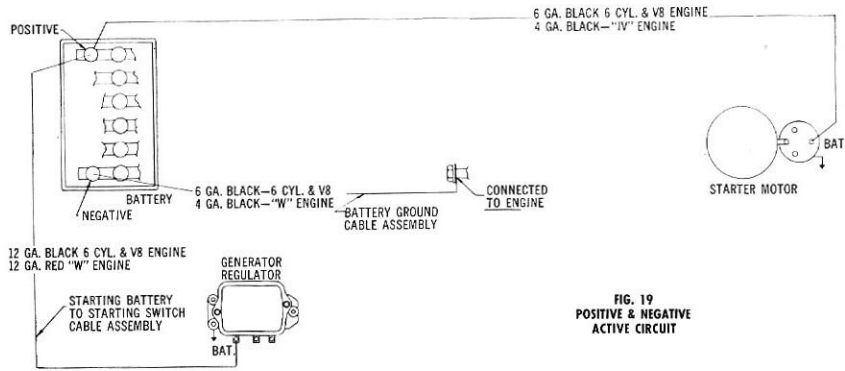


FIG. 19
POSITIVE & NEGATIVE
ACTIVE CIRCUIT

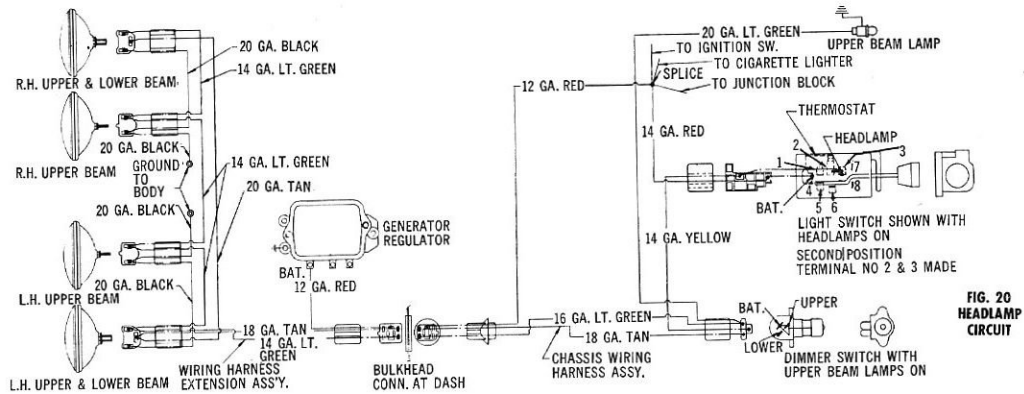


FIG. 20
HEADLAMP
CIRCUIT

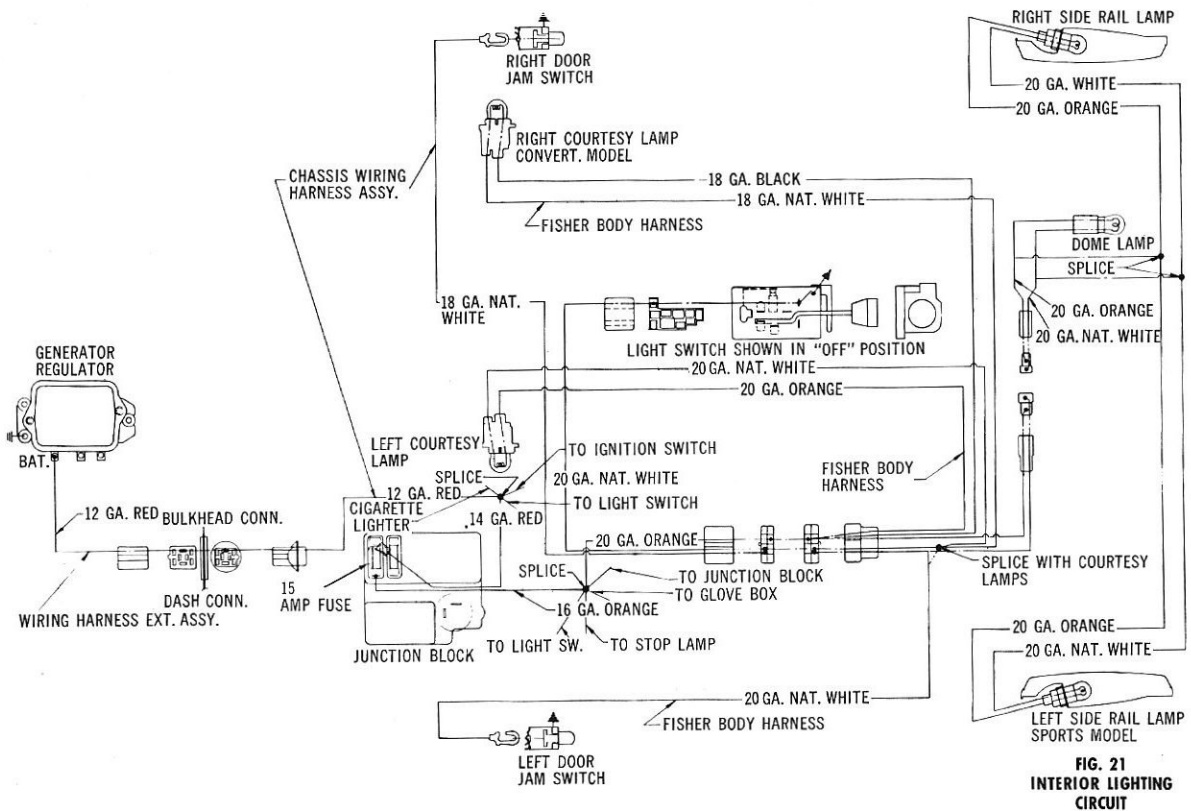
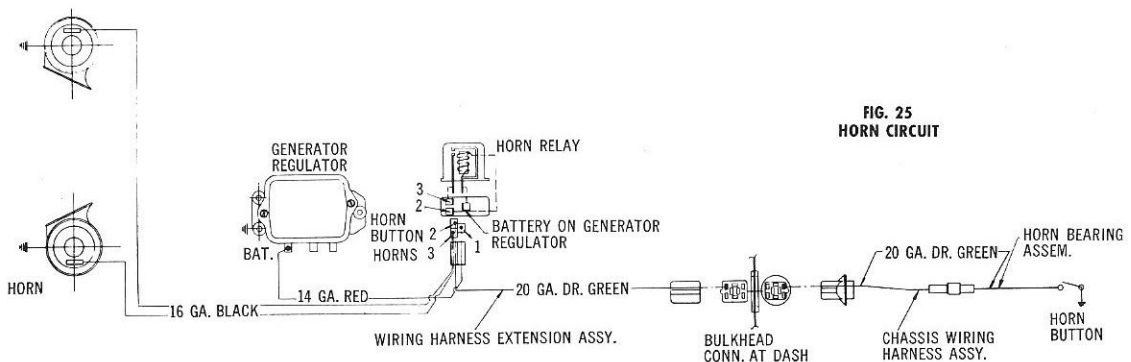
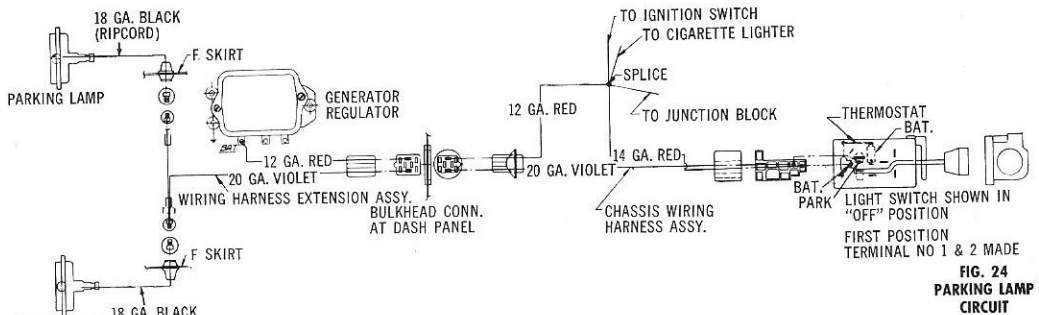
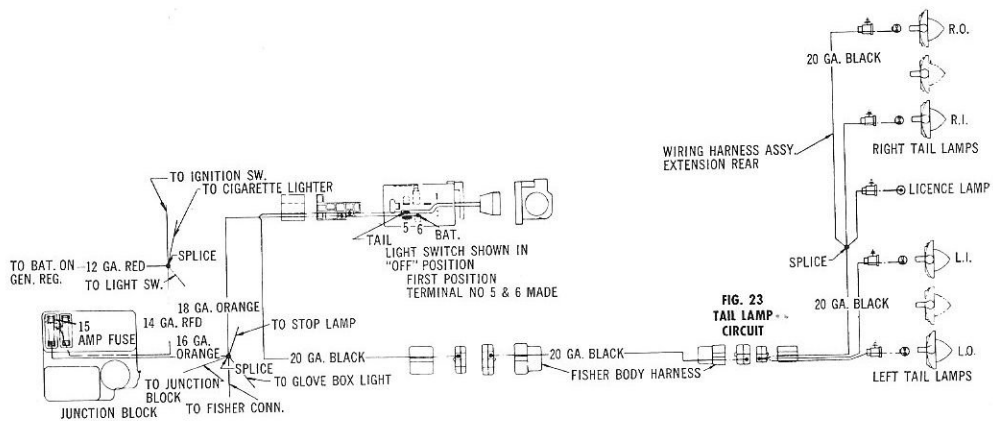
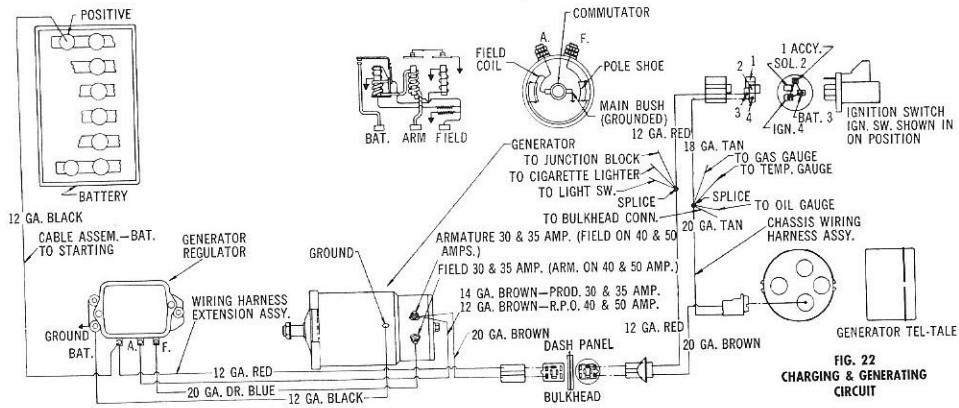
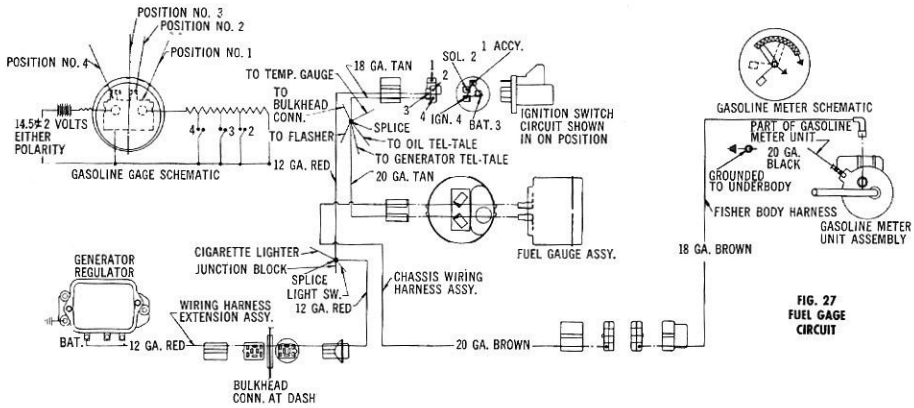
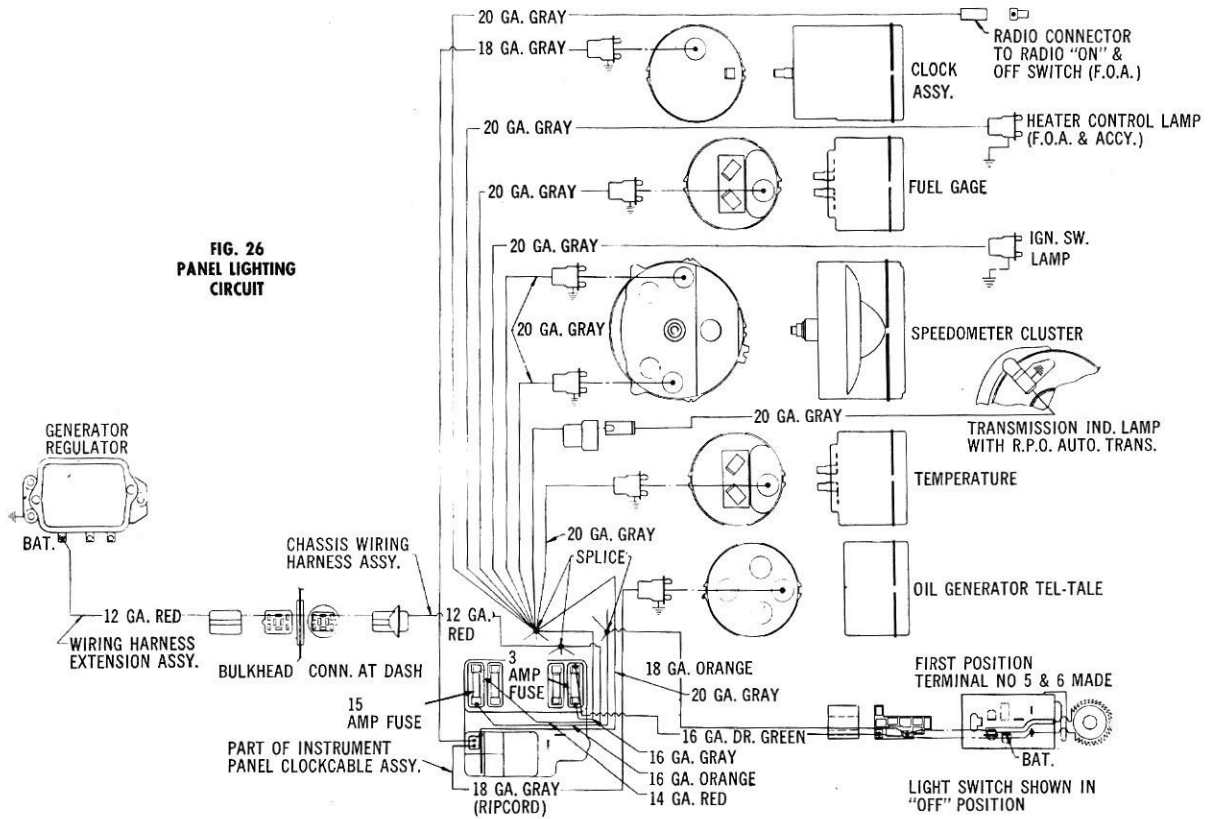


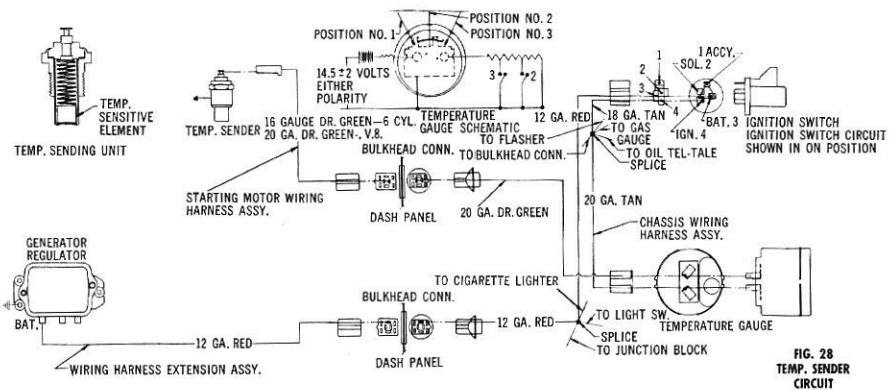
FIG. 21
INTERIOR LIGHTING
CIRCUIT



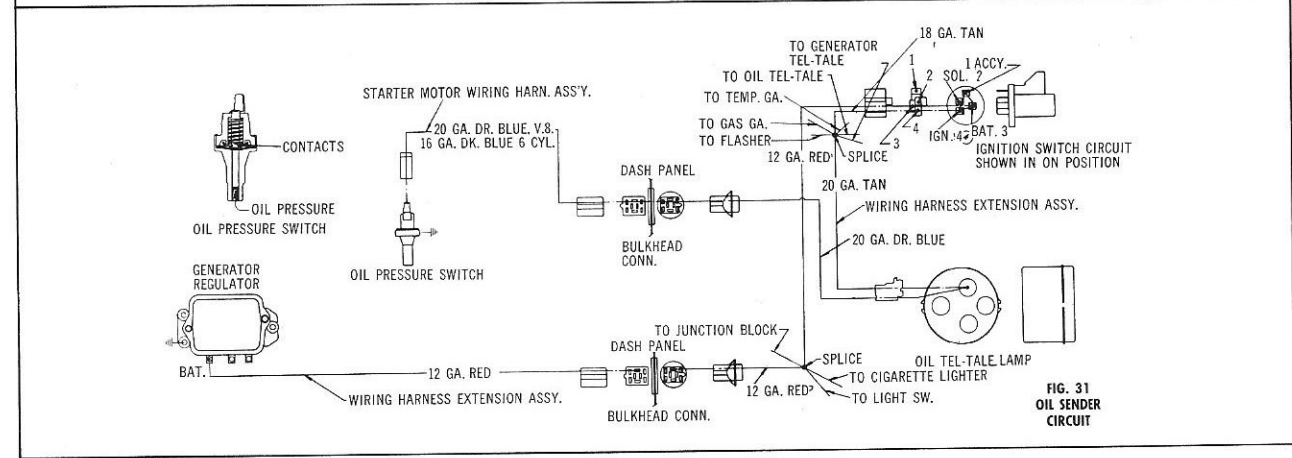
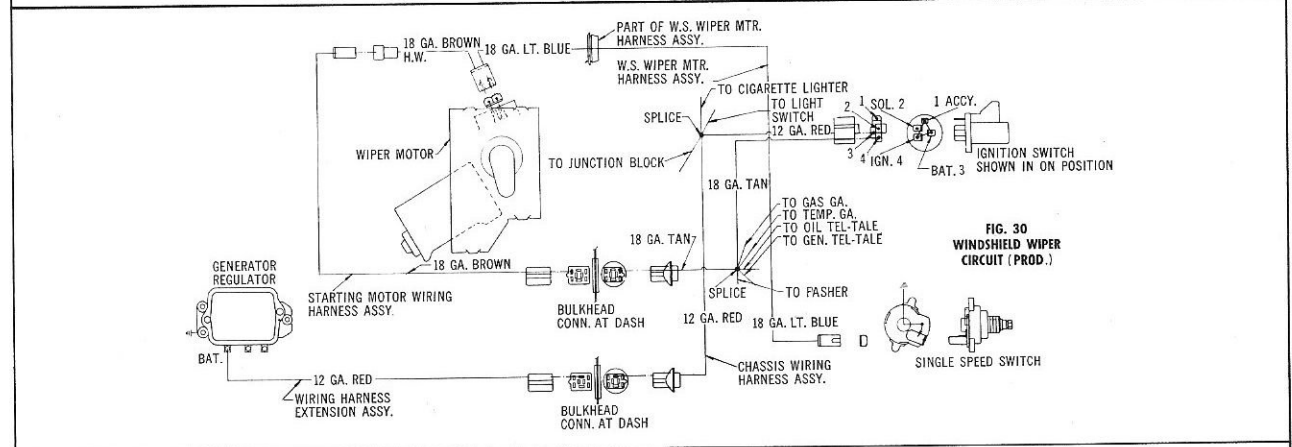
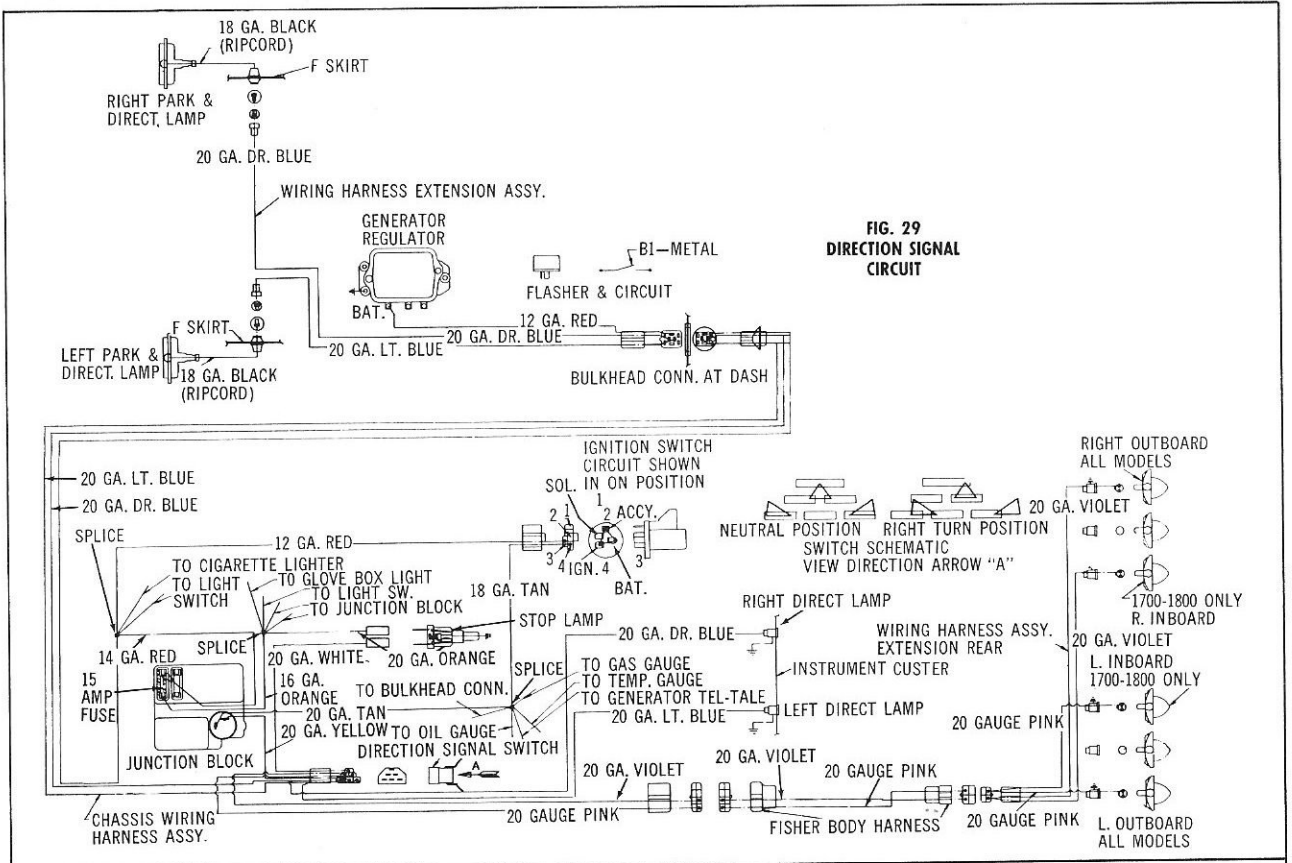
**FIG. 26
PANEL LIGHTING
CIRCUIT**

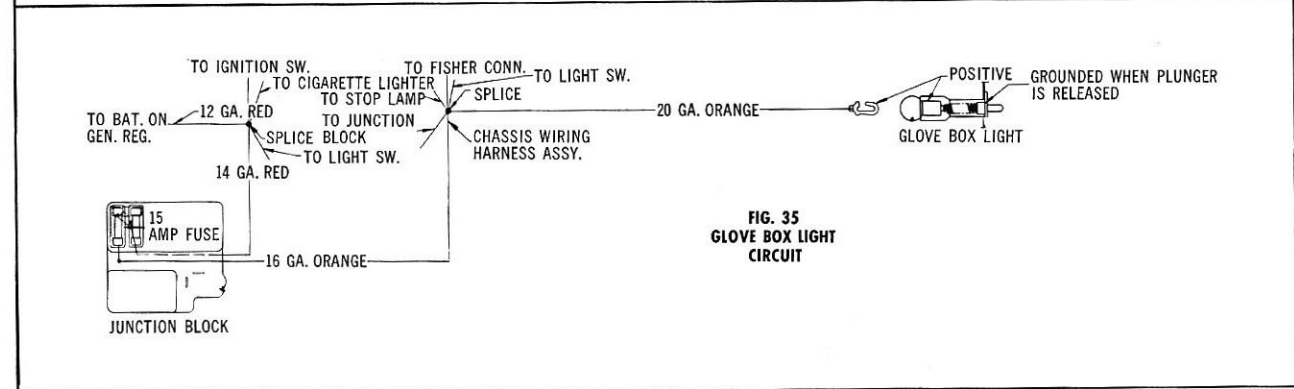
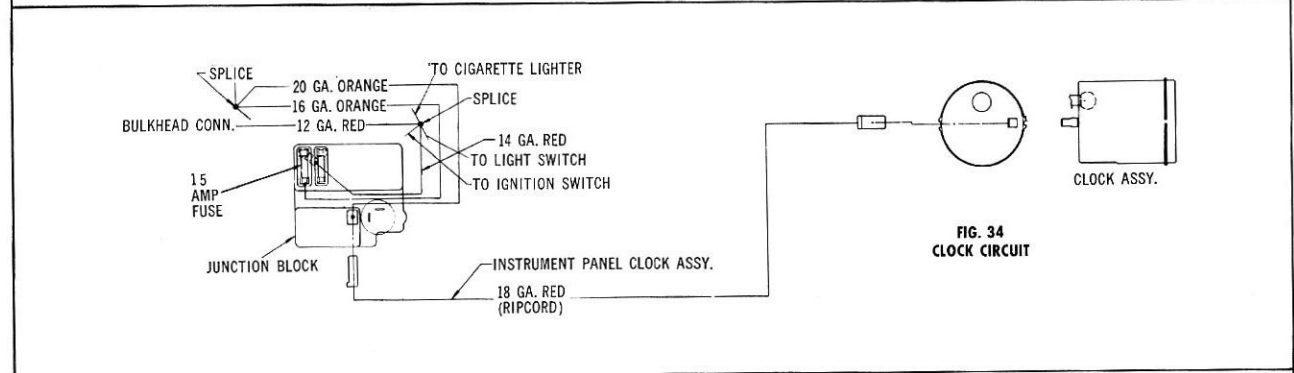
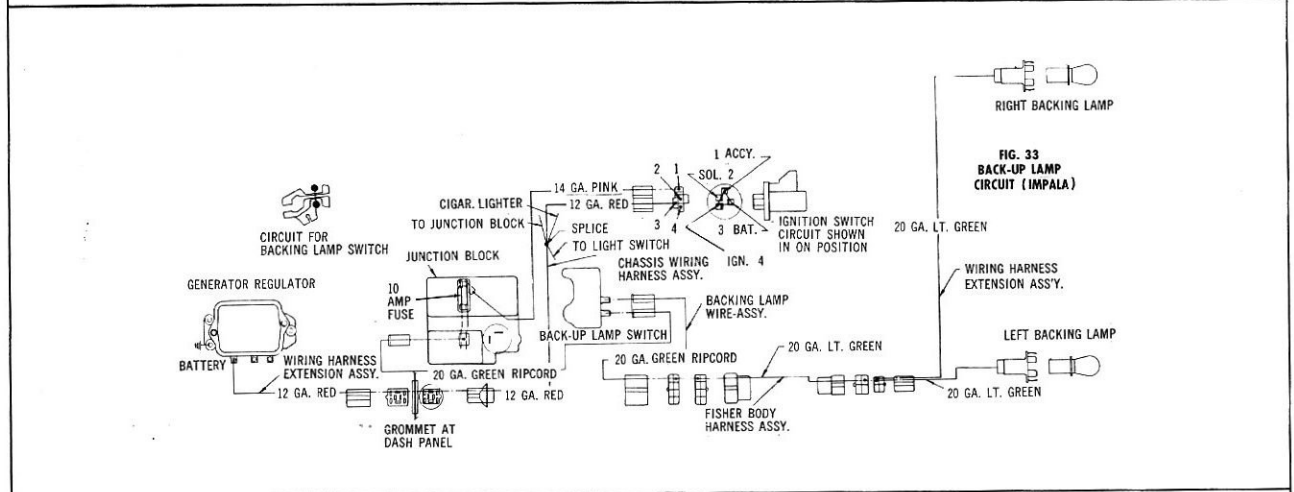
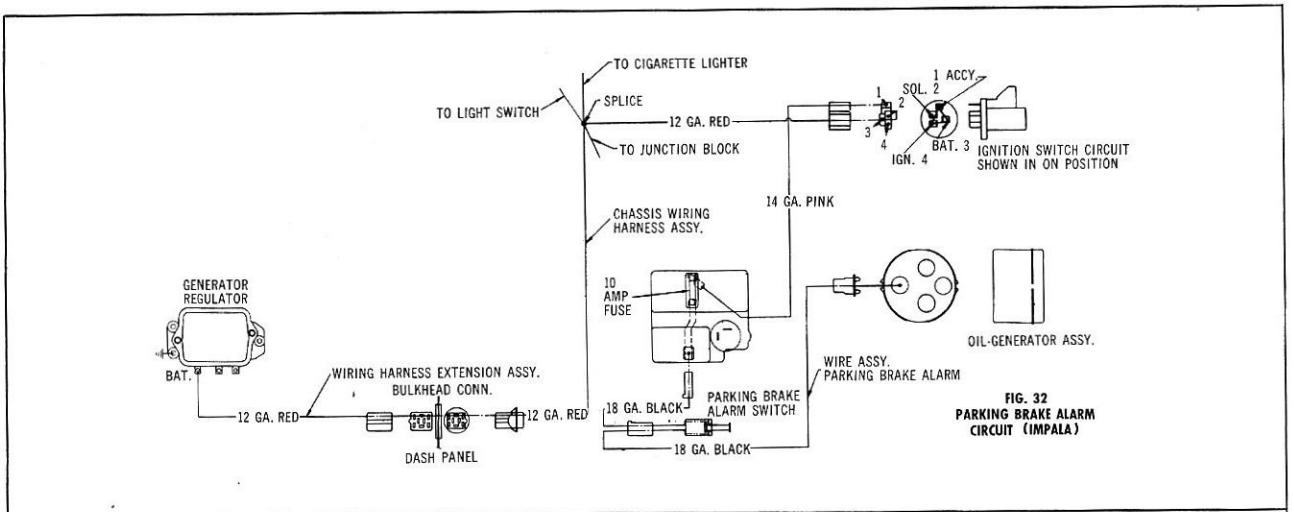


**FIG. 27
FUEL GAGE
CIRCUIT**



**FIG. 28
TEMP. SENDER
CIRCUIT**





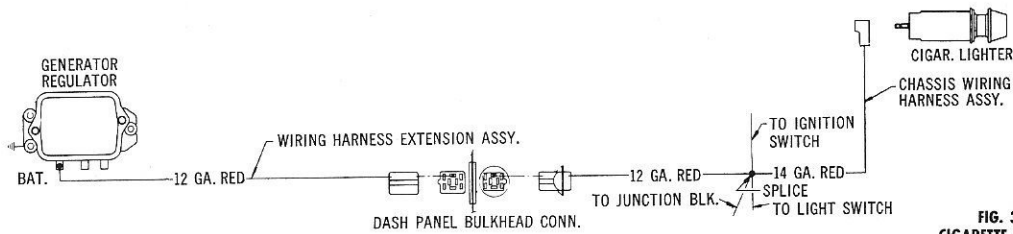


FIG. 36
CIGARETTE LIGHTER
CIRCUIT

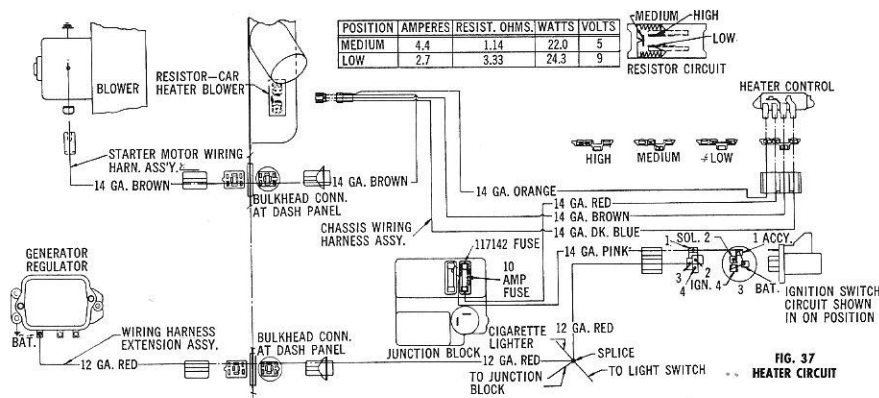


FIG. 37
HEATER CIRCUIT

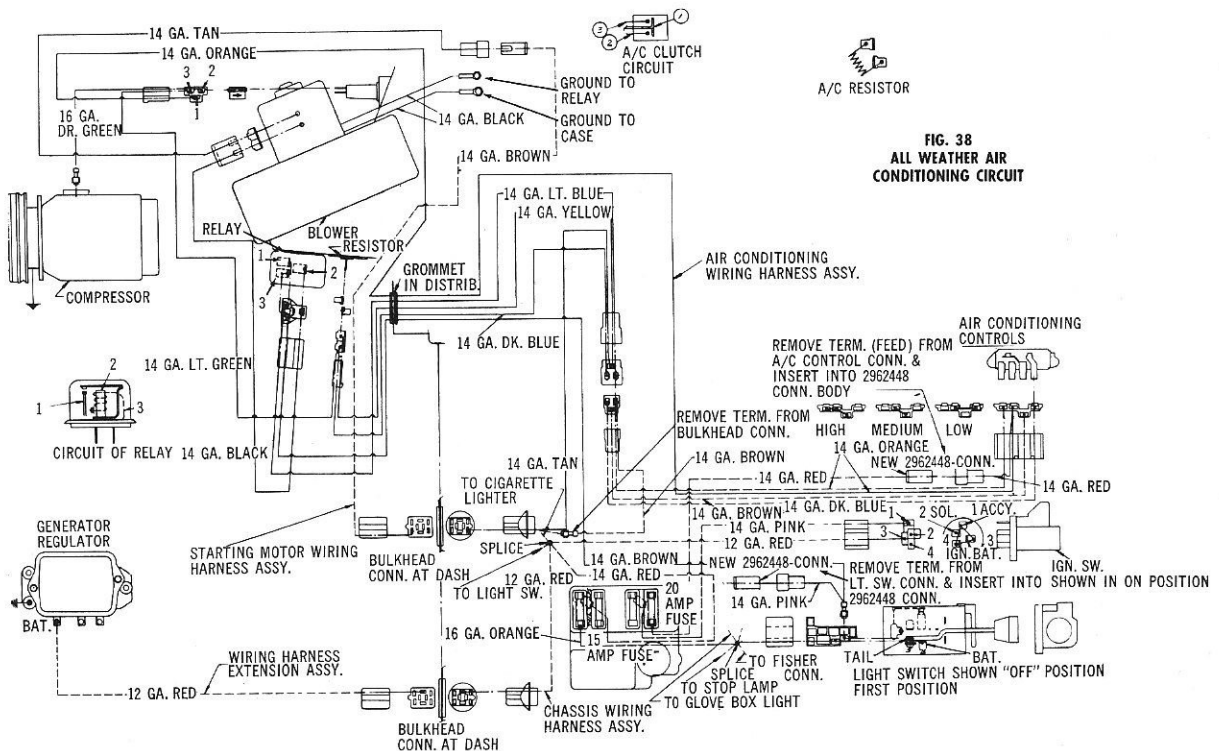


FIG. 38
ALL WEATHER AIR
CONDITIONING CIRCUIT

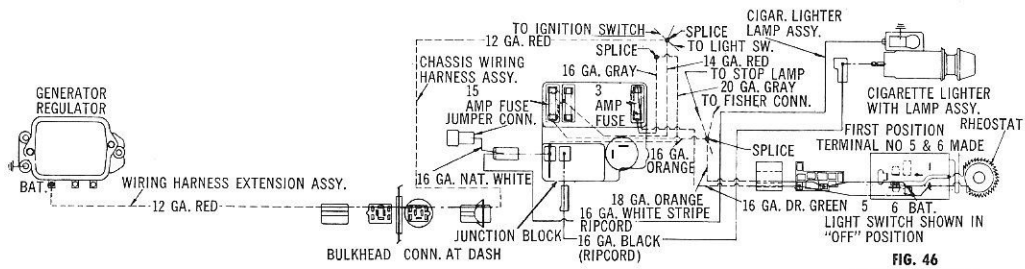


FIG. 46
CIGARETTE LIGHTER
CIRCUIT (EX. IMPALA)

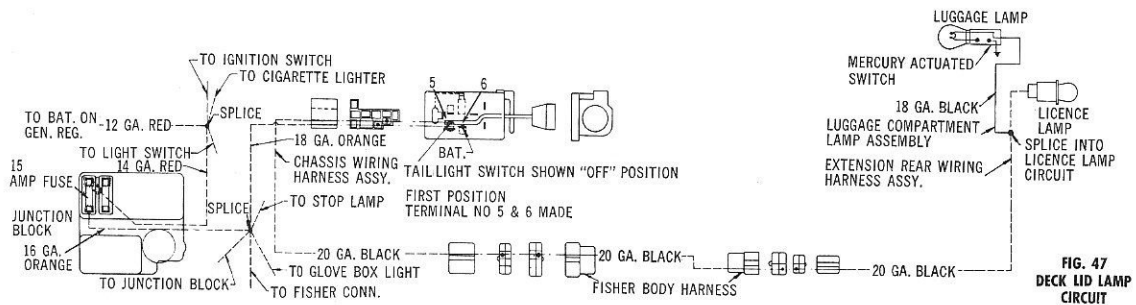


FIG. 47
DECK LID LAMP
CIRCUIT

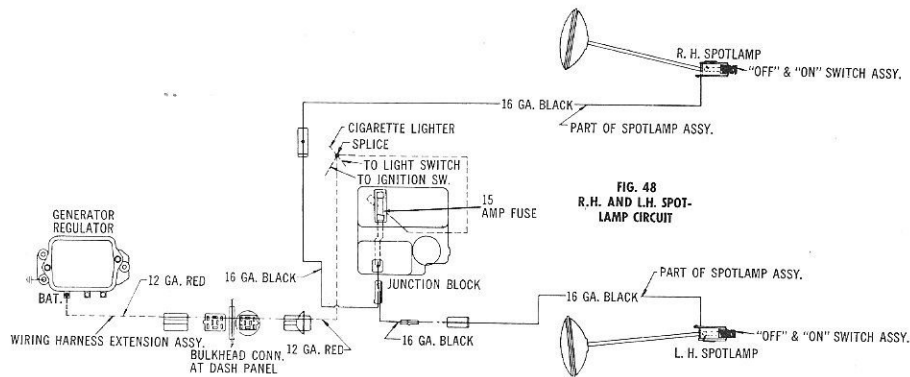


FIG. 48
R.H. AND L.H. SPOT-
LAMP CIRCUIT

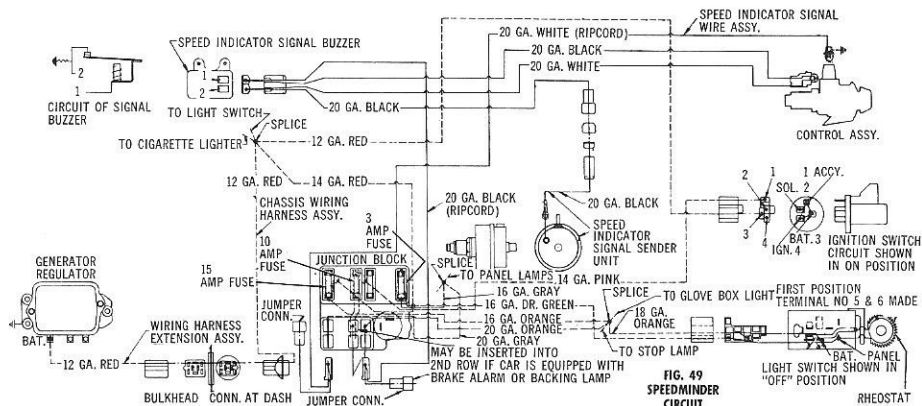


FIG. 49
SPEEDMINDER
CIRCUIT

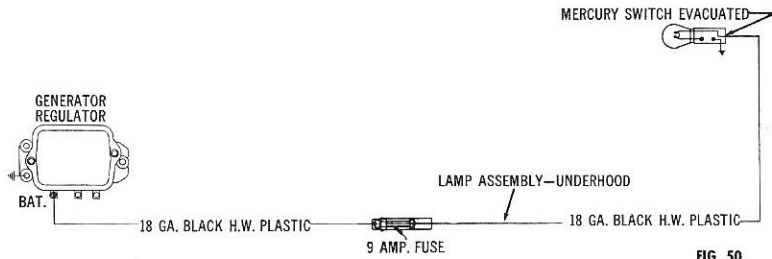


FIG. 50
UNDERHOOD LAMP
CIRCUIT

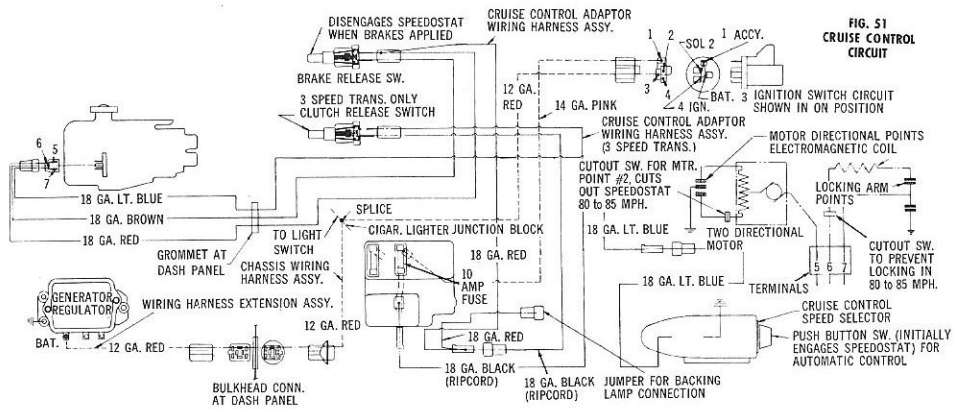


FIG. 51
CRUISE CONTROL
CIRCUIT

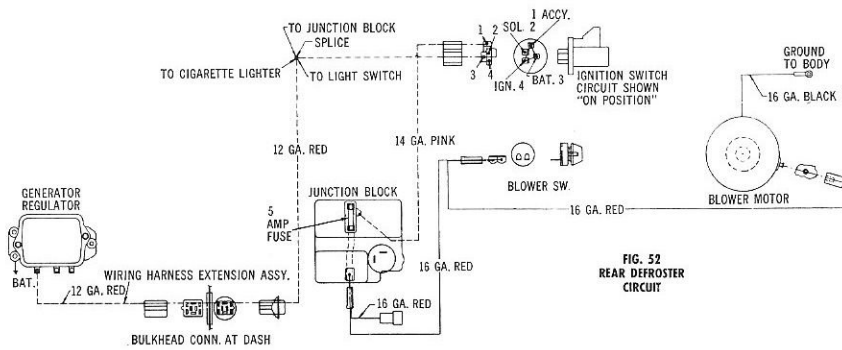


FIG. 52
REAR DEFROSTER
CIRCUIT

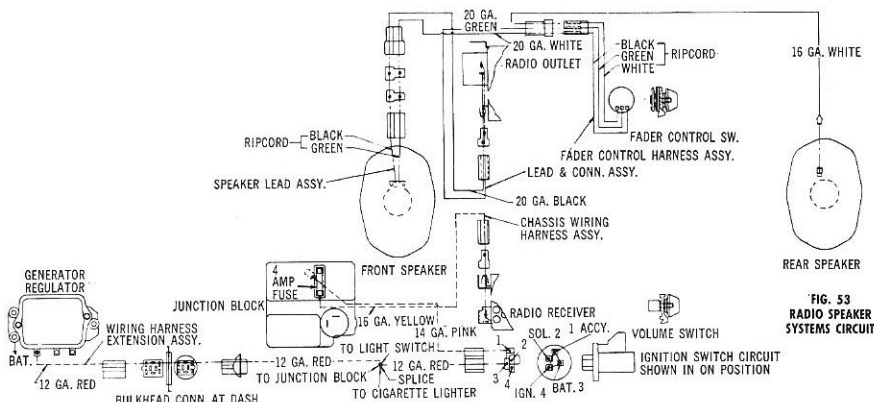


FIG. 53
RADIO SPEAKER
SYSTEMS CIRCUIT

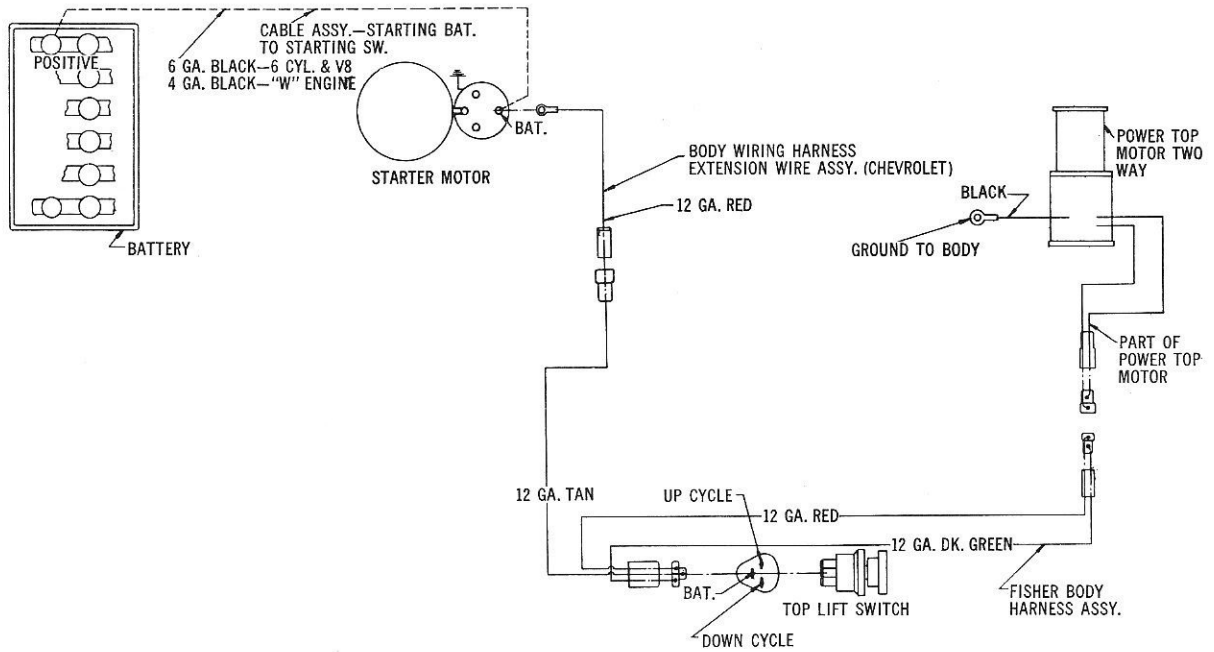


FIG. 57
POWER TOP
(CONVERTIBLE) CIRCUIT

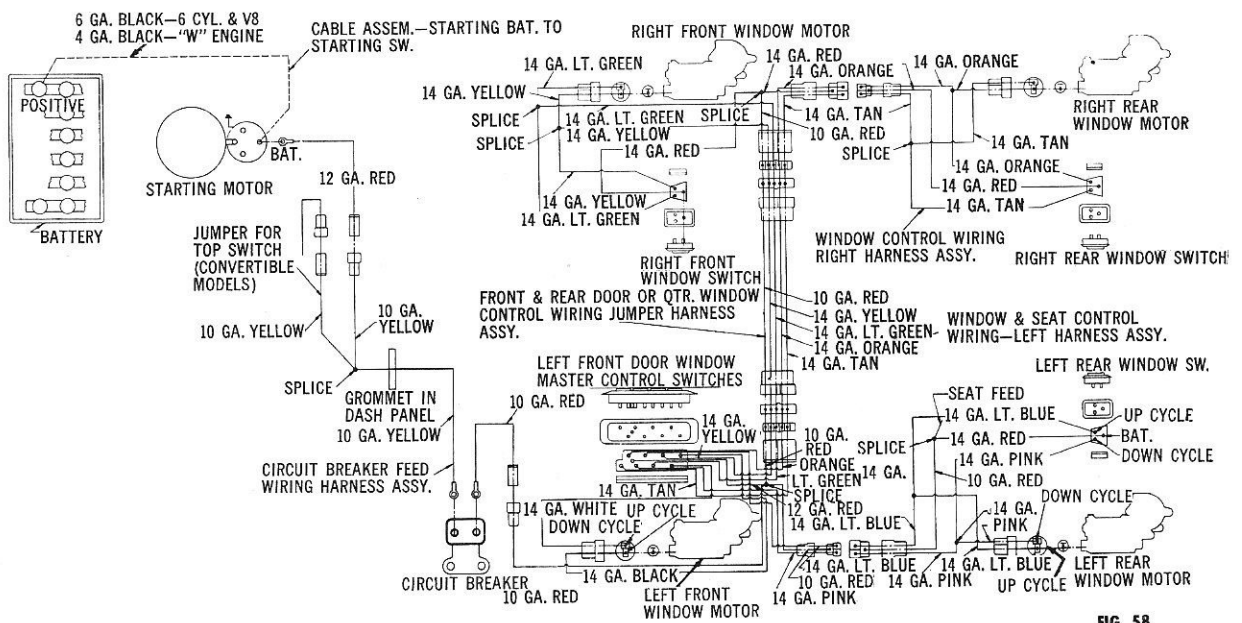


FIG. 58
POWER WINDOW
CIRCUIT

WIRING DIAGRAM

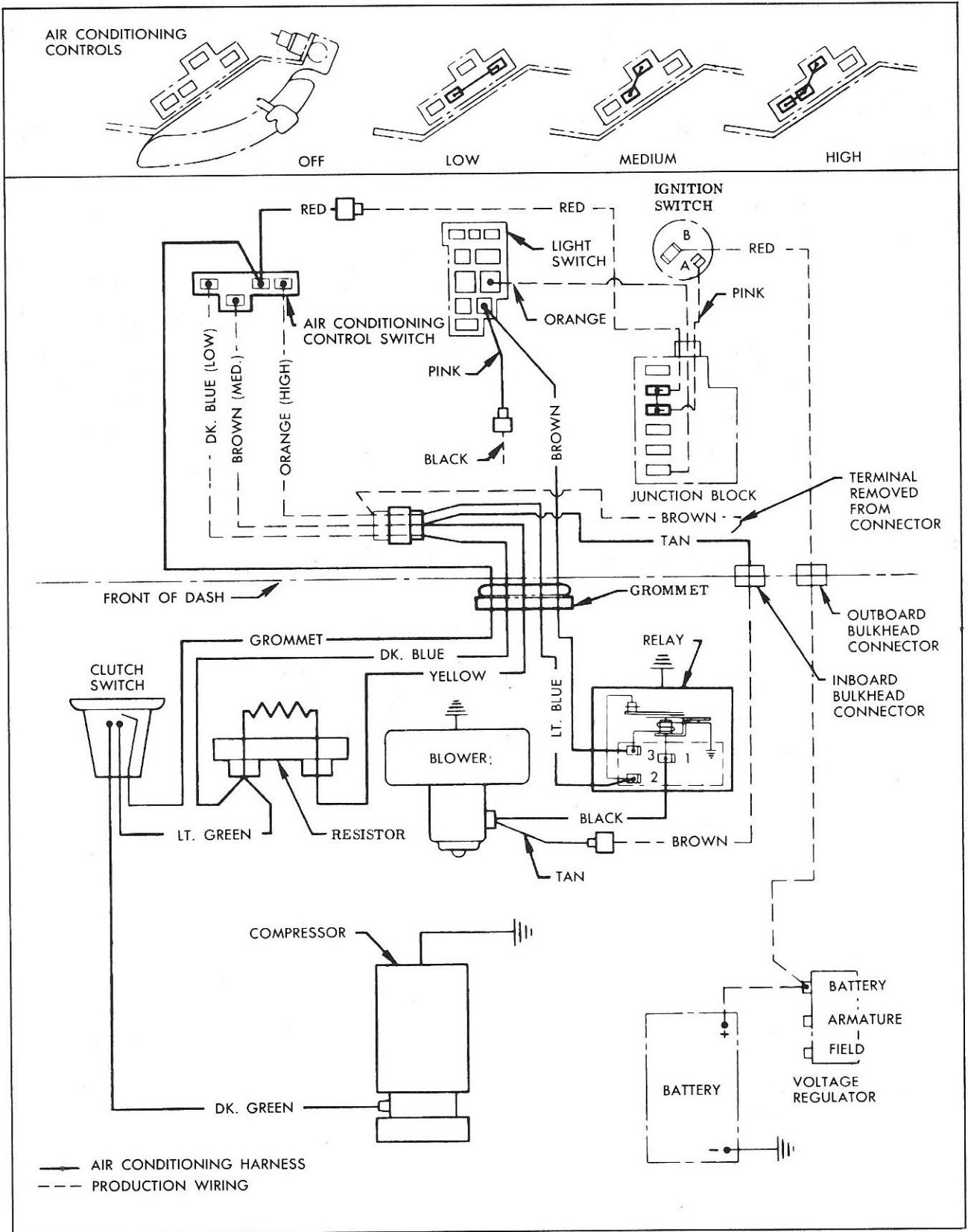


Fig. 14—Wiring Diagram, All-Weather Air Conditioning System

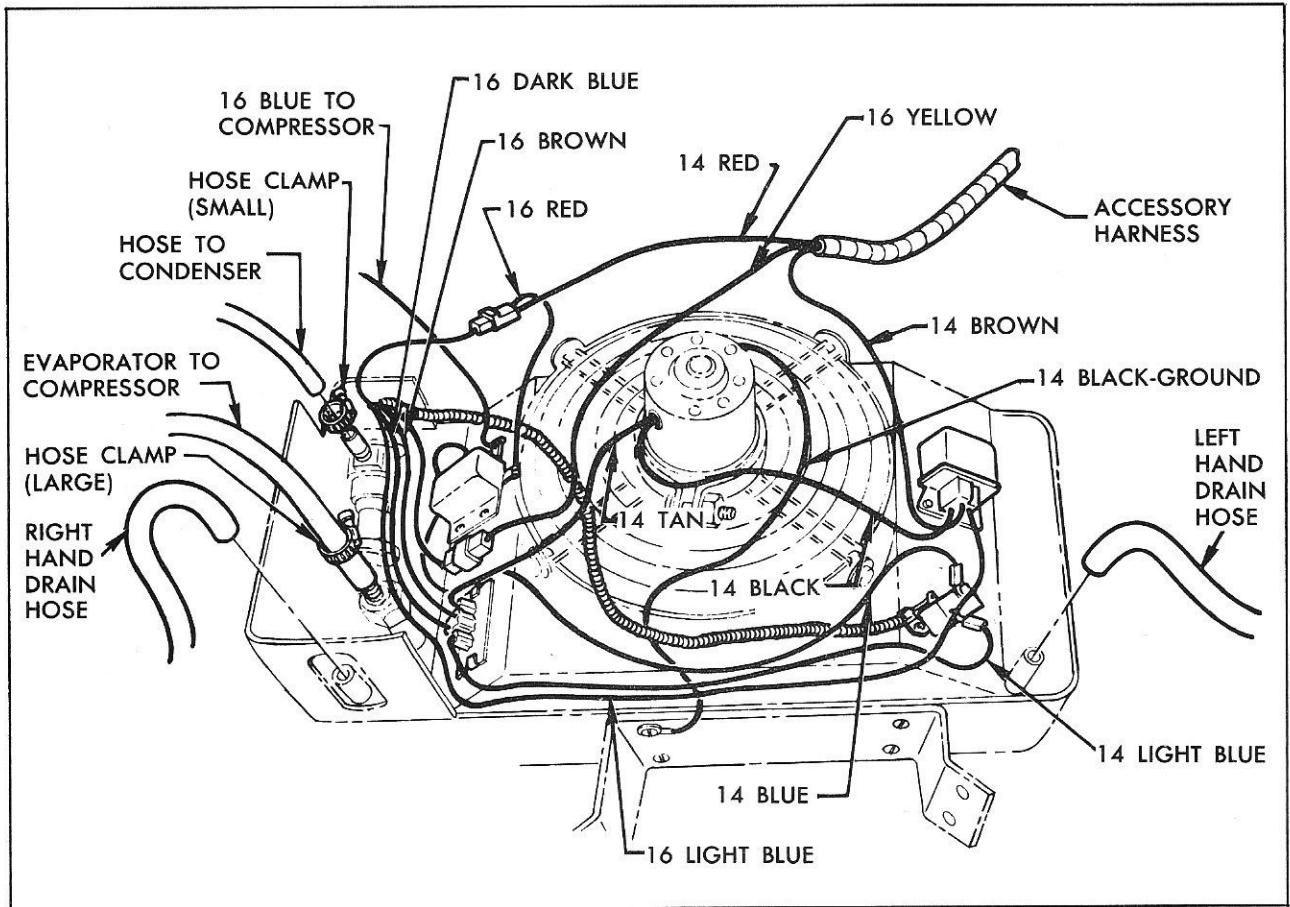


Fig. 34—Rear View of Evaporator—1959

